

000134. Christmas Advent Calendar



Material

- Paper/Cardstock – 5 kinds
- Ribbon (5 mm (W) x 50 cm) - 5 pieces
- Red wooden beads (diameter 9 mm) - 25 pieces
- Christmas-pattern cloth (Approx. 65 cm x 50 cm)
- A2-size frame
- Corrugated board or cardboard (size to fit the frame)
- Glue
- Glue gun or liquid adhesive agent

(1) Cut out parts A through D. Cut parts A, B, and C (25 pieces each).

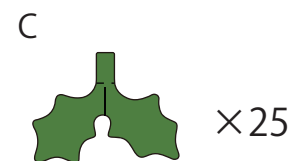
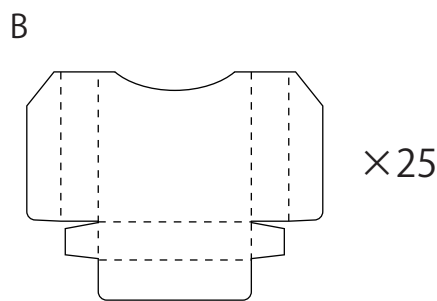
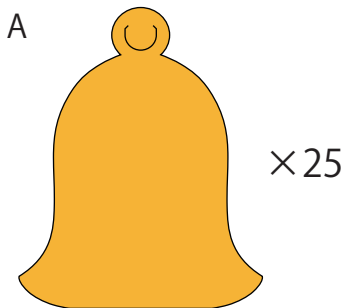

D-1

1 2 3 4 5 6 7 8 9 10

11 12 13 14 15 16 17

18 19 20 21 22 23 24

D-2

25

(2) Glue the D-1 parts and D-2 parts (calendar dates) to the B parts.

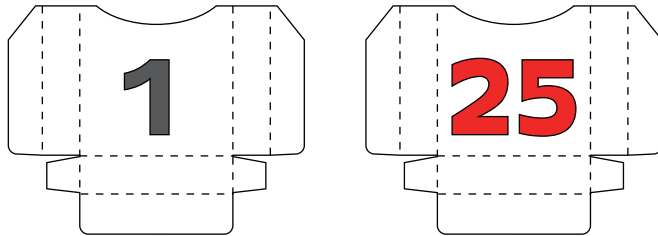

(3) Fold the B parts along the dotted lines as shown below, and then glue them to the A parts.

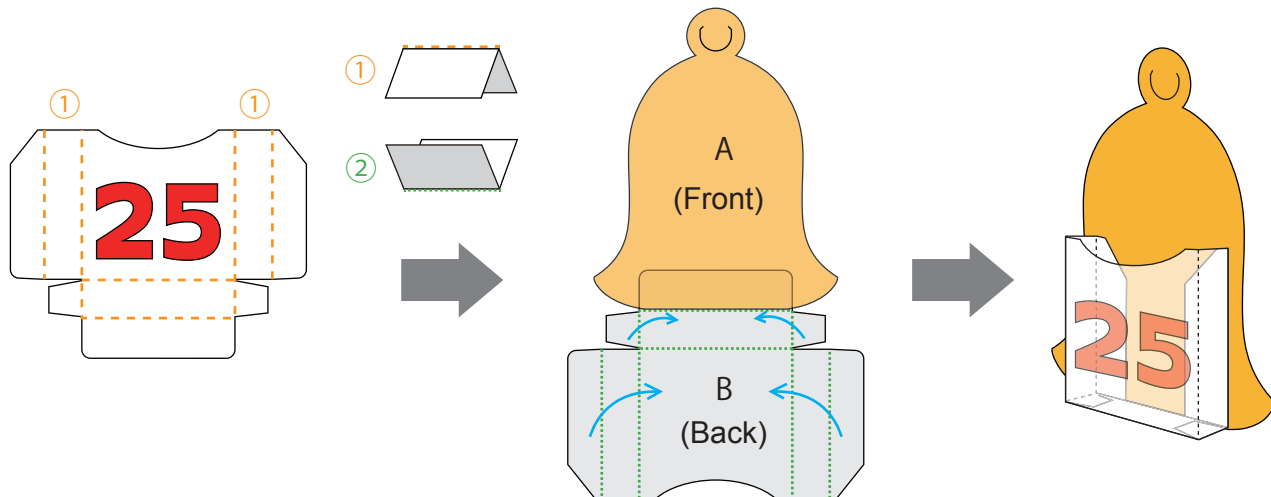

(4) Slightly overlap the sections of the C parts along the cut line. Fold the C parts along the dotted line, then pass it through the cutout of the A parts and glue it. Attach the wooden beads to the C parts using a glue gun or liquid adhesive agent.

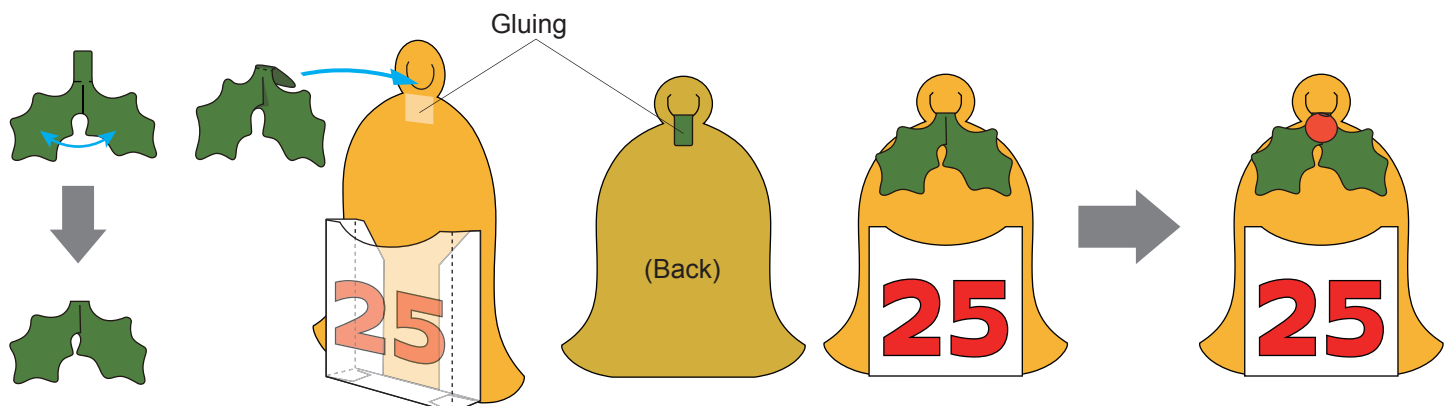

(5) Glue the Christmas-pattern cloth onto a piece of corrugated board or cardboard that is the same size as the frame. Attach both edges of the five ribbons on the back side as shown below, then put the cloth in the frame.

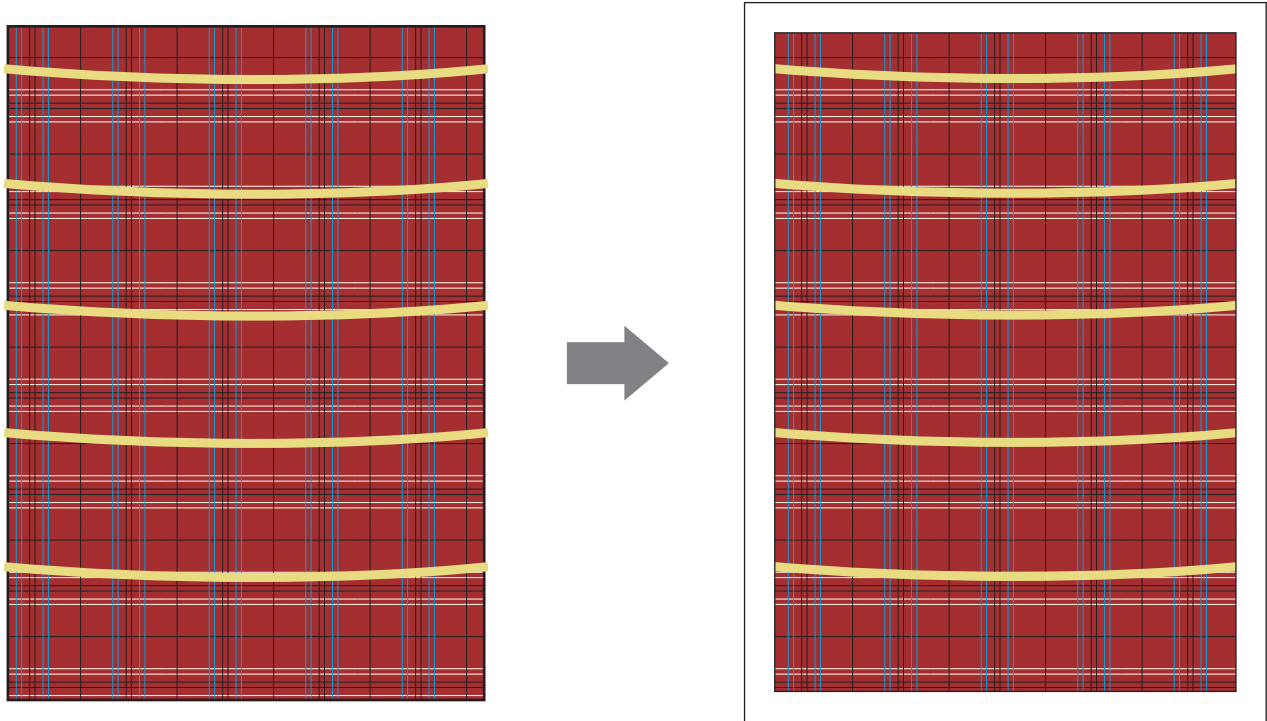

(6) Arrange parts with dates 1 through 25 that you made in step (4) as shown below, then hook the cutout of each bell on the ribbon.

